



32 Channel, Gain 20 and 140 Tethered Headstages



Headstage Features

- Custom VLSI circuit provides small size & reduced weight
- Weight < 0.8 grams
- 34 channels total (32 data channels and 2 reference channels)
- Available with gain of 20 and 140
- Unity gain ground buffer output
- Selectable bandpass filtering per channel
- $\pm 1.65V/\pm 2.5V$ operation
- Size: 3x14x20 mm

Triangle BioSystems, Int'l. offers a family of 32-channel analog headstage subassemblies that are used to provide a wired connection between implanted electrodes and neural recording and analysis equipment. The main function of the headstage is to precondition the neuron pulse signals and provide a high gain, bandpass filtered buffered connection over a low impedance cable. Each headstage design is based on a custom, low power VLSI developed by TBSI. The result is a solution with superior performance in a very small form-factor with less weight.

The 32-channel high gain, bandpass filter headstages are available with gains of 20 and 140 with a selectable bandpass filter.

System Overview



NeuroWare™ Certified

These products are not for human use.

Block Diagram

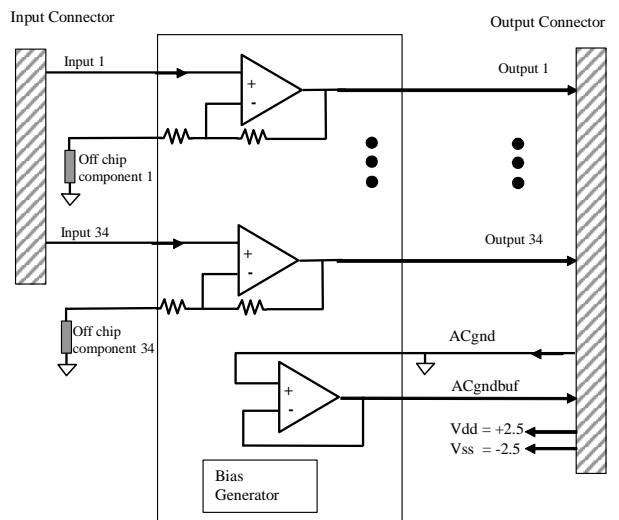

Headstage Specifications

Parameter	Min	Typ	Max	Units	Notes
Power Supply					
±1.65 volt supply	3.0	3.3	3.6	Volts	3.3V Bipolar power supply (± 1.65V)
Average Icc	5.6	6.1	6.7	mA	
±3.0 volt supply	5.6	5.75	6.0	Volts	6V Bipolar power supply (± 3.0V)
Average Icc	6.9	7.1	7.5	mA	
Analog Channel					
Input voltage range (±3.0V)	-.145		.145	Volts	For 6V Bipolar power supply for G20
Input voltage range (±1.65V)	-.081		.081	Volts	For 3.3V Bipolar power supply for G20
Common mode center		0		Volts	For bipolar power supplies only
DC Offset	-5	0	5	mVolts	For bipolar power supplies only
Voltage Gain 20	19.8	20	20.2		Factory selectable gain
Voltage Gain 140	138	140	143		Factory selectable gain
G20 BW @ ±2.5V	.4		300	kHz	-3dB input signal level BW
G140 BW @ ±2.5V	.4		45	kHz	-3dB input signal level BW
Input impedance		50		Mohms	At 1kHz
Output impedance		158		ohms	At 1kHz
Input referred noise		3.6		µVrms	for DC - 10KHz frequency with all inputs grounded
Input referred noise		1.8		µVrms	for .8 Hz to 500 Hz frequency with all inputs grounded
Input referred noise		1.2		µVrms	for 500 Hz to 8KHz frequency with all inputs grounded
THD			-63	dB	@ 5kHz and 1V p-p input
Phase Delay		30		uSecs	@ 5 kHz input
Settling Time		5.5		uSecs	With 1V step input
Mechanical Specs					
Gain 20 & Gain 140		1.2 x 2.1		mm	Edge to Edge of die W x L, 100 um height
Weight Gain 20/140			.1	grams	
Miscellaneous					
Reference Bias Current		78		µA	Included inside headstage
Junction Temperature	-40	25	100	C	

Custom VLSI ASIC

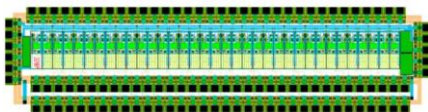

Compact Size Headstage

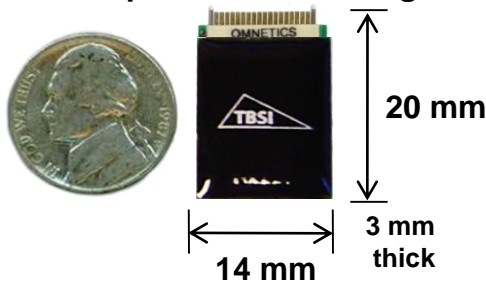

Ordering Information

Headstage Connectors

Mate logo to logo for correct connector orientation.

Looking At Input Connector (Omnetics A8829) From Probes:

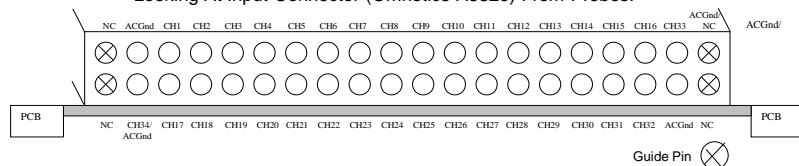

Looking At Output Connector (Omnetics A8830) From Monitor Side:

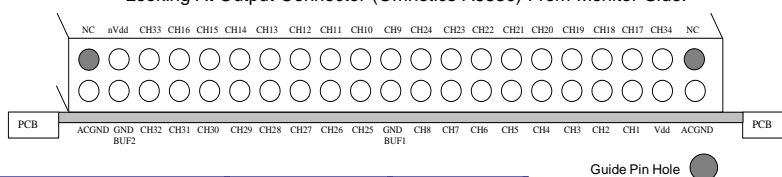

Part No.	Gain	BP Filter
Neuro34BPG20	Gain 20	Yes
Neuro34BPG140	Gain 140	Yes
A9114 Electrode Cable	12 inches	
A9115 Record Cable	36 inches	

Application Notes

Available Grounding and Referencing Connections for T32G20,100 Headstage:

ACGND: Connect your animal ground to ACGND (see pinout diagram on pg2) of the headstage. This is typically connected to earth or system ground (which is 0V potential) of the recording system.

CH33,34: These are extra recording channels that can be used as common mode reference signals for external preamplifiers. These common mode reference channels are useful for removing animal movement artifacts or any other common mode noise found at the headstage input pins.

ACGNDBUF: With ACGND as the positive input, this pin uses a unity gain source follower to provide another common mode reference option for the preamplifier. NOTE: The ACGNDBUF is DC coupled with unity gain and does not have the same bandpass filter characteristics as channels 1-34. Therefore the common mode noise rejection when using ACGNDBUF may not be as effective as channels 1-34.

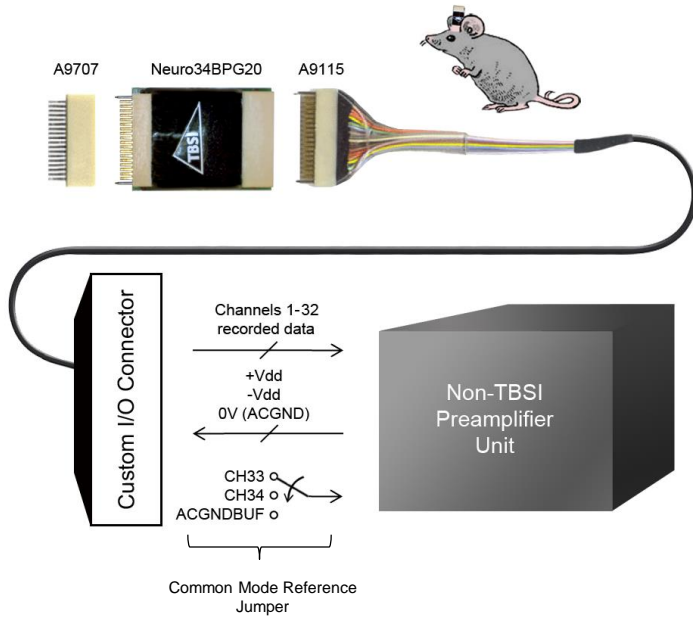

Front View

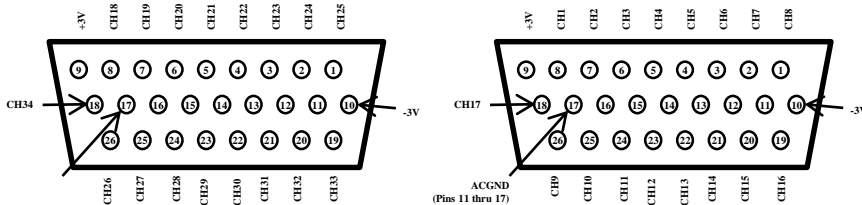

Rear View



* USB power option not available for 32ch T-series recording unit

Gain 20

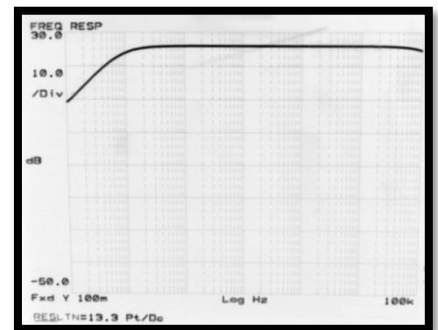

Gain 140

