

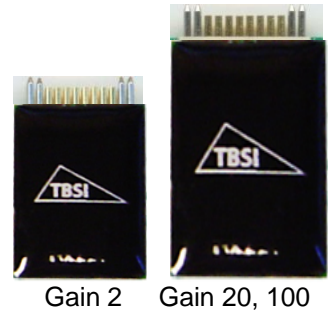

Triangle BioSystems, Int'l.

16 Channel Tethered Headstages Gain 2, 20 and 100



Headstage Features

- Custom VLSI circuit provides small size & reduced weight
- Weight < 0.75 grams
- 17 channels total (16 data channels and 1 reference channel)
- Available with gain of 2, 20, 100
- Unity gain ground buffer output
- Selectable bandpass filtering per channel
- $\pm 1.65V/\pm 2.5V$ operation
- Gain 2 size: 3 x 8 x 15 mm
Gain 20 & 100 size: 3 x 9 x 20 mm

Triangle BioSystems, Int'l. offers a family of 16-channel analog headstage subassemblies that are used to provide a wired connection between implanted electrodes and neural recording and analysis equipment. The main function of the headstage is to precondition the neuron pulse signals and provide a buffered connection over a low impedance cable. Each headstage design is based on a custom, low power VLSI developed by TBSI. The result is a solution with superior performance in a very small form-factor with less weight.

The 16-channel headstages are available with gains of 2, 20, 100. With the exception of the gain 2 device, all headstages include a selectable bandpass filter.

System Overview



NeuroWare™ Certified

Block Diagram

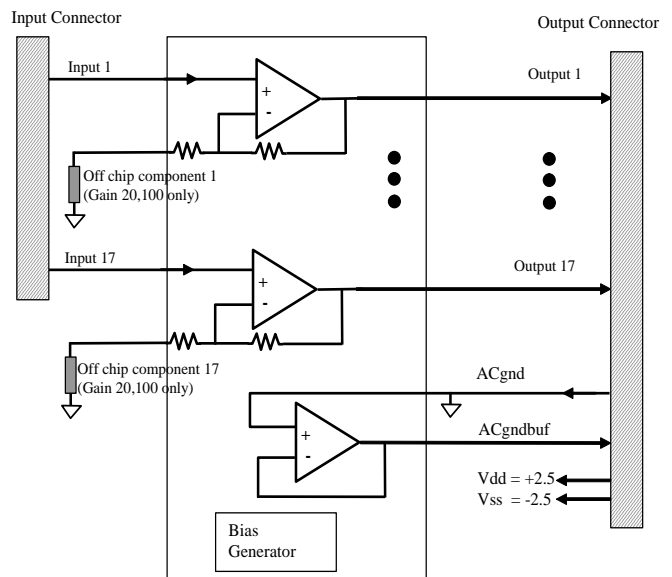

*does not apply to gain 1000 version

Headstage Specifications

Electrical

Parameter	Min	Typ	Max	Units	Notes
Power Supply					
±1.65 volt supply	3.0	3.3	3.6	Volts	3.3V Bipolar power supply (± 1.65V)
Average Icc	5.6	6.1	6.7	mA	
±2.5 volt supply	4.5	5	5.5	Volts	5V Bipolar power supply (± 2.5V)
Average Icc	6.8	7.5	8.5	mA	
Analog Channel					
Input voltage range (±2.5V)	-1.2	0	1.8	Volts	For 5V Bipolar power supply
Input voltage range (±1.65V)	-6		.8	Volts	For 3.3V Bipolar power supply
Common mode center		0		Volts	For bipolar power supplies only
DC Offset	-10	0	10	mVolts	For bipolar power supplies only
Voltage Gain 2	1.9	2	2.1		Factory selectable gain
Voltage Gain 20	19.8	20	20.2		Factory selectable gain
Voltage Gain 100	95	100	105		Factory selectable gain
G2 BW @ ±2.5V			250	kHz	DC coupled
G20 BW @ ±2.5V	.8		150	kHz	-3dB input signal level BW
G100 BW @ ±2.5V	.8		22	kHz	-3dB input signal level BW
Input impedance		50		Mohms	At 1kHz
Output impedance		158		ohms	At 1kHz
Input referred noise		5.1		µVrms	for DC - 10kHz frequency with all inputs grounded
THD			-63	dB	@ 5kHz and 1V p-p input
Phase Delay		30		uSecs	@ 5 kHz input
Settling Time		5.5		uSecs	With 1V step input
Mechanical Specs					
Gain 2 (H x L x W)	3	8	15	mm	Edge to Edge of connector pins H x W x L
Gain 20 & Gain 100	3	9	20	mm	Edge to Edge of connector pins H x W x L
Weight Gain 2			.4	grams	
Weight Gain 20			.7	grams	
Miscellaneous					
Reference Bias Current		78		uA	Included inside headstage
Junction Temperature	-40	25	100	C	

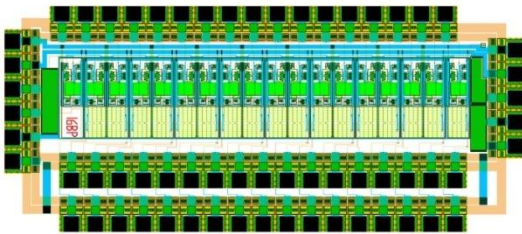

Custom VLSI ASIC



Compact Size

Connectors

Mate logo to logo for correct connector orientation.

Looking At Input Electrode Connector (Omnetics A8783-001):

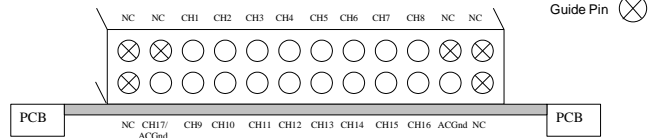

Looking At Output Connector (Omnetics A8811):

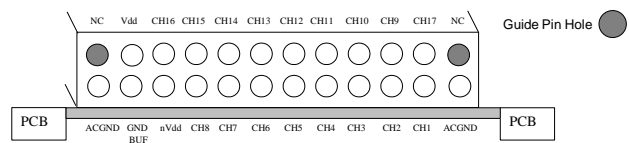

Ordering Information

Part No.	Gain	BP Filter
Neuro16G2	Gain 2	No
Neuro16BPG20	Gain 20	Yes
Neuro16BPG100	Gain 100	Yes



Available Grounding and Referencing Connections for T16G2,20,100 Headstage:

ACGND: Connect your animal ground to ACGND (see pinout diagram on pg2) of the headstage. This is typically connected to earth or system ground (which is 0V potential) of the recording system.

CH17: This is an extra recording channel that can be used as a common mode reference signal for external preamplifiers. This common mode reference channel is useful for removing animal movement artifacts or any other common mode noise found at the headstage input pins.

ACGNDBUF: With ACGND as the positive input, this pin uses a unity gain source follower to provide another common mode reference option for the preamplifier. NOTE: The ACGNDBUF is DC coupled with unity gain and does not have the same bandpass filter characteristics as channels 1-17. Therefore the common mode noise rejection when using ACGNDBUF may not be as effective as channels 1-17.

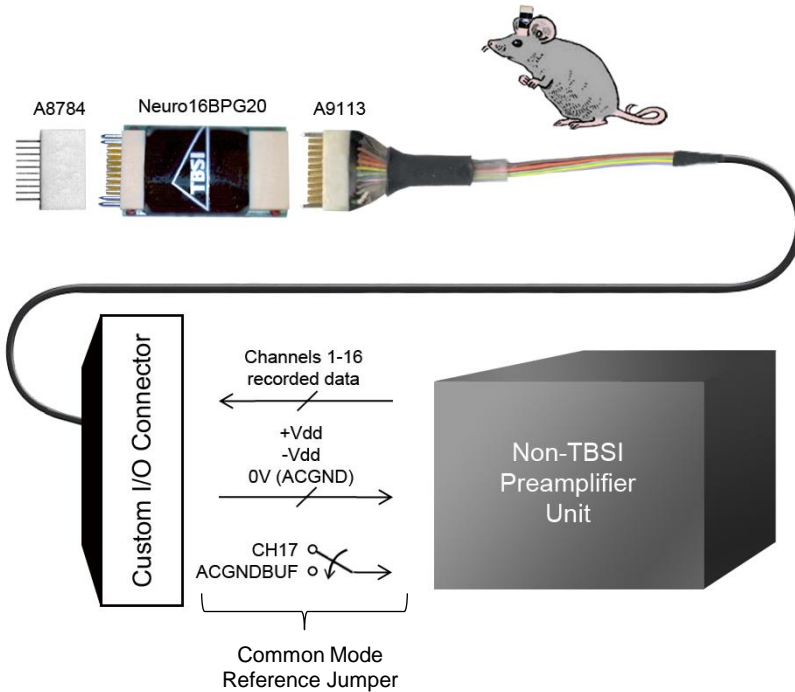

Front View

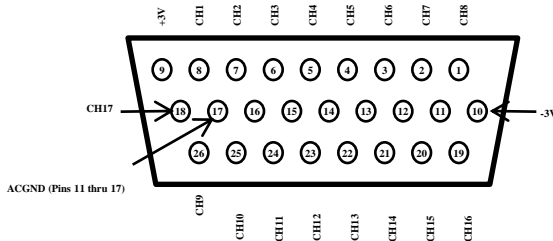

Rear View



* 16ch T-series recording unit is exclusively powered via USB

Gain 2

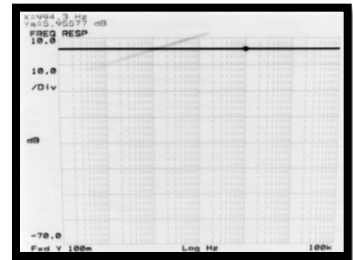

Gain 20

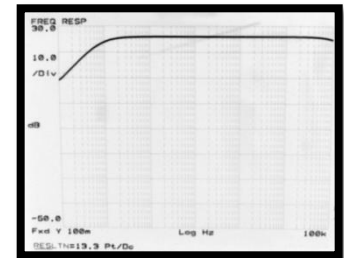

Gain 100

