



Triangle BioSystems, Int'l.



32 Channel Tethered Gain 2 Headstage

Headstage Features

- Custom VLSI circuit provides small size & reduced weight
- Weight < 0.8 grams
- 34 channels total (32 data channels and 2 reference channels)
- Voltage gain of 2
- Bandwidth is DC to 48khz
- Unity gain ground buffer output
- $\pm 1.65V / \pm 2.5V$ operation
- Size: 3.6x14x15 mm

Triangle BioSystems, Int'l. offers the smallest 32-channel analog headstage subassembly that is used to provide a wired connection between implanted electrodes and neural recording and analysis equipment. The main function of the headstage is to precondition the neuron pulse signals and provide a buffered connection over a low impedance cable. Each headstage design is based on a custom, low power VLSI developed by TBSI. The result is a solution with superior performance in a very small form-factor with less weight.

System Overview



NeuroWare™ Certified

*does not apply to gain 1000 version

Block Diagram

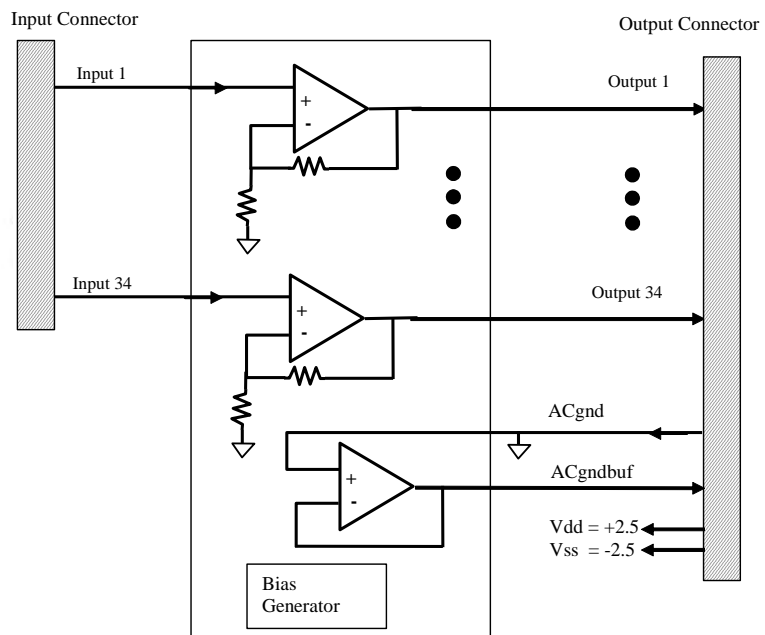

Headstage Specifications

Electrical

Parameter	Min	Typ	Max	Units	Notes
Power Supply					
±1.65 volt supply	3.0	3.3	3.6	Volts	3.3V Bipolar power supply (±1.65V)
Average Icc	5.6	6.1	6.7	mA	
±2.5 volt supply	4.5	5	5.5	Volts	5V Bipolar power supply (± 2.5V)
Average Icc	6.8	7.5	8.5	mA	
Analog Channel					
Input voltage range (±2.5V)	-1.2	0	1.8	Volts	For 5V Bipolar power supply
Input voltage range (±1.65V)	-6		.8	Volts	For 3.3V Bipolar power supply
Common mode center		0		Volts	For bipolar power supplies only
DC Offset	-10	0	10	mVolts	For bipolar power supplies only
Gain	1.9	2	2.1		Factory selectable gain
Amplifier Bandwidth	dc		48	kHz	-3dB input signal level BW is DC to 48khz
Input impedance		22		Mohms	At 1kHz
Output impedance		158		ohms	At 1kHz
Input referred noise		5.7		µVrms	for DC - 10khz frequency with all inputs grounded
THD			-63	dB	@ 5kHz and 1V p-p input
Phase Delay		30		uSecs	@ 5 kHz input
Settling Time		5.5		uSecs	With 1V step input
Mechanical Specs					
Length		15		mm	Edge to Edge of connector pins
Width		14		mm	
Height		3.6		mm	
Weight			.8	grams	
Miscellaneous					
Reference Bias Current		78		uA	Included inside headstage
Junction Temperature	-40	25	100	C	

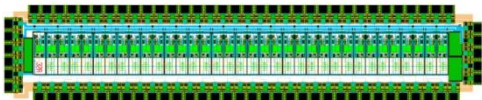

Custom VLSI Gain 2 ASIC

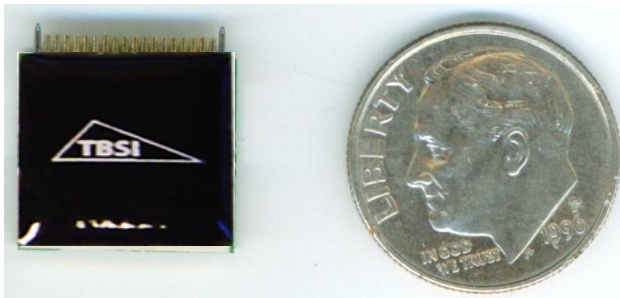

Smallest 32 channel Headstage



Headstage Connectors

Mate logo to logo for correct connector orientation.

Looking At Input Connector (Omnetics A8829) From Probes:

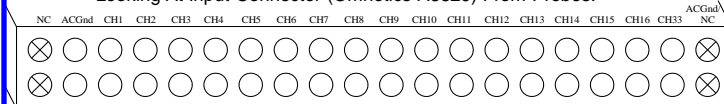

Looking At Output Connector (Omnetics A8830) From Monitor Side:

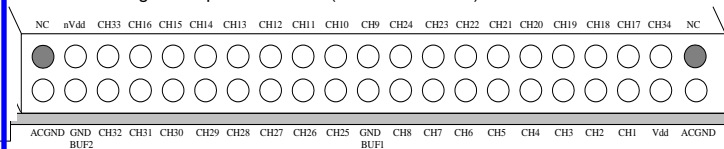

Ordering Information

Part No.		
Neuro34G2sm	Headstage	
A9114	Electrode Cable	
A9115	Recorder Cable	

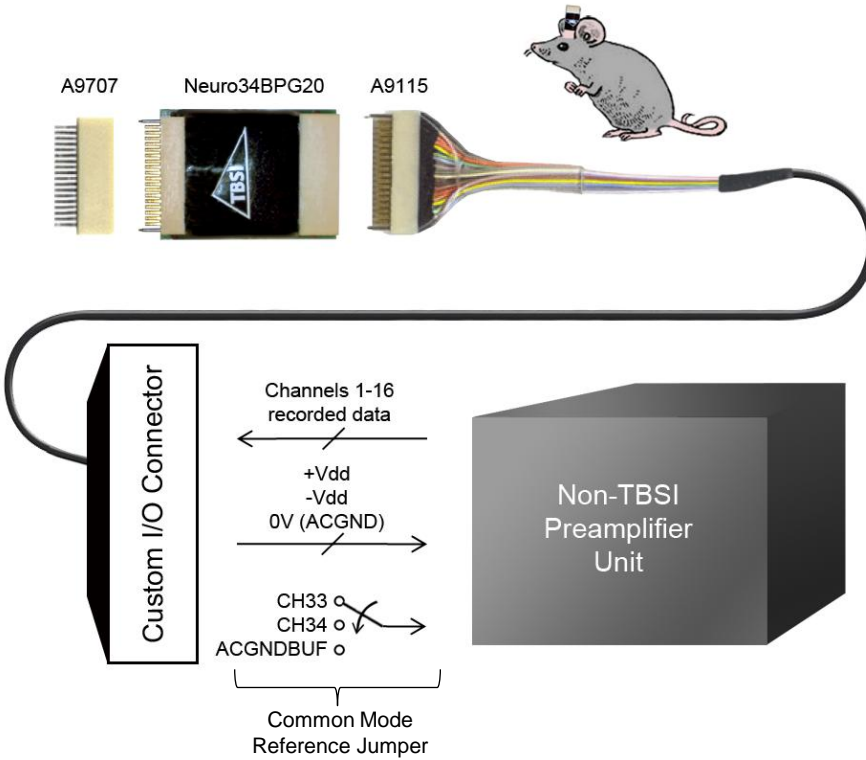

Available Grounding and Referencing Connections for T32G20,100 Headstage:

ACGND: Connect your animal ground to ACGND (see pinout diagram on pg2) of the headstage. This is typically connected to earth or system ground (which is 0V potential) of the recording system.

CH33,34: These are extra recording channels that can be used as common mode reference signals for external preamplifiers. These common mode reference channels are useful for removing animal movement artifacts or any other common mode noise found at the headstage input pins.

ACGNDBUF: With ACGND as the positive input, this pin uses a unity gain source follower to provide another common mode reference option for the preamplifier. NOTE: The ACGNDBUF is DC coupled with unity gain and does not have the same bandpass filter characteristics as channels 1-34. Therefore the common mode noise rejection when using ACGNDBUF may not be as effective as channels 33 and 34.

Front View

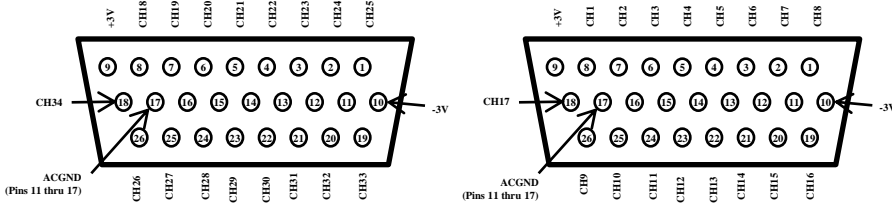

Rear View



* USB power option not available for 32ch T-series recording unit

