

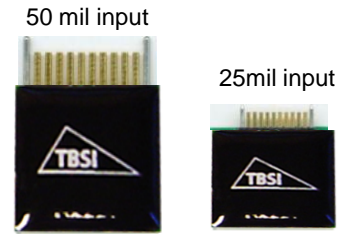

Triangle BioSystems, Int'l.



8 Channel Gain 2 Tethered Headstages

Headstage Features

- Custom VLSI circuit provides small size & reduced weight
- Weight < 0.9 grams
- 9 channels (8ch plus 1 reference)
- Available with gain of 2
- Unity gain ground buffer output
- Selectable bandpass filtering per channel
- $\pm 1.65V/\pm 2.5V$ operation
- Size for Gain 2:
5x18x17mm for 50mil Input Omnetics
5x12x12mm for 25mil Input Omnetics

Triangle BioSystems, Int'l. offers a family of 8-channel analog headstage subassemblies that are used to provide a wired connection between implanted electrodes and neural recording and analysis equipment. The main function of the headstage is to precondition the neuron pulse signals and provide a buffered connection over a low impedance cable. Each headstage design is based on a custom, low power VLSI developed by TBSI. The result is a solution with superior performance in a very small form-factor with less weight.

The 8-channel headstages are available with gain of 2.

System Overview



NeuroWare™ certified

*does not apply to gain 1000 version

Block Diagram

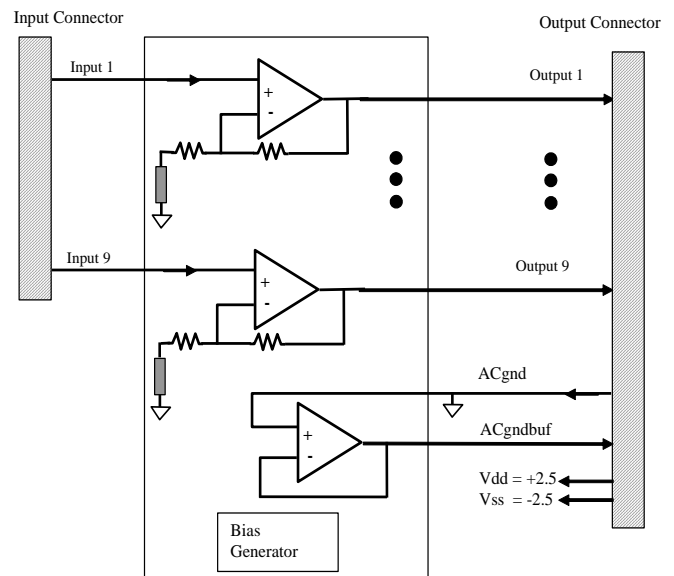

Electrical

Parameter	Min	Typ	Max	Units	Notes
Power Supply					
±1.65 volt supply	3.0	3.3	3.6	Volts	3.3V Bipolar power supply ($\pm 1.65V$)
Average Icc	5.6	6.1	6.7	mA	
±2.5 volt supply	4.5	5	5.5	Volts	5V Bipolar power supply ($\pm 2.5V$)
Average Icc	6.8	7.5	8.5	mA	
Analog Channel					
Input voltage range ($\pm 2.5v$)	-1.2	0	1.8	Volts	For 5v Bipolar power supply
Input voltage range ($\pm 1.65v$)	-0.6		.8	Volts	For 3.3v Bipolar power supply
Common mode center		0		Volts	For bipolar power supplies only
dc Offset	-10	0	10	mVolts	For bipolar power supplies only
Gain 2	1.9	2	2.1		Factory selectable gain
G2 BW @ $\pm 2.5V$.8		120	kHz	-3dB input signal level BW
Input impedance		22		Mohms	At 1kHz
Output impedance		158		ohms	At 1kHz
Input referred noise		5.7		μV_{rms}	for DC - 10kHz frequency with all inputs grounded
THD			-63	dB	@ 5kHz and 1V p-p input
Phase Delay		30		uSecs	@ 5 kHz input
Settling Time		5.5		uSecs	With 1V step input
Mechanical Specs					
Length		15		mm	Edge to Edge of connector pins
Width		14		mm	
Height		3.0		mm	
Weight			.8	grams	
Miscellaneous					
Reference Bias Current		78		uA	Included inside headstage
Junction Temperature	-40	25	100	C	

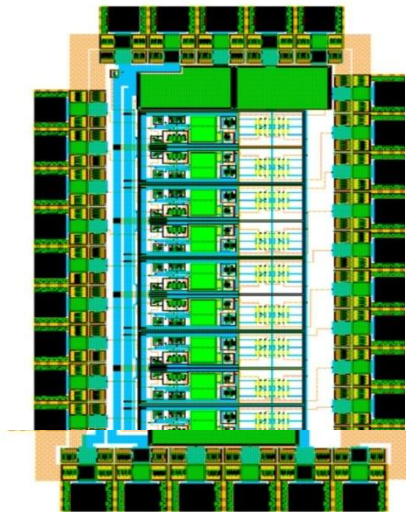

Gain 2 die

Electrode Side Omnetics Connector

Mate logo to logo for correct connector orientation.

Looking At Input Electrode Connector (50mil is PN A11862 or 25mil is PN is A8376-001)

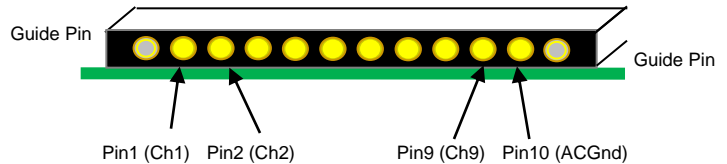

Electrode mating 25 mil connector is Omnetics PN A8393-001
Electrode mating 50 mil connector is Omnetics PN A11449

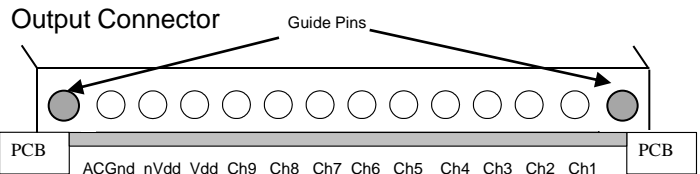

Ordering Information

Part No.	Gain	BP Filter
Neuro8G2	Gain 2	No



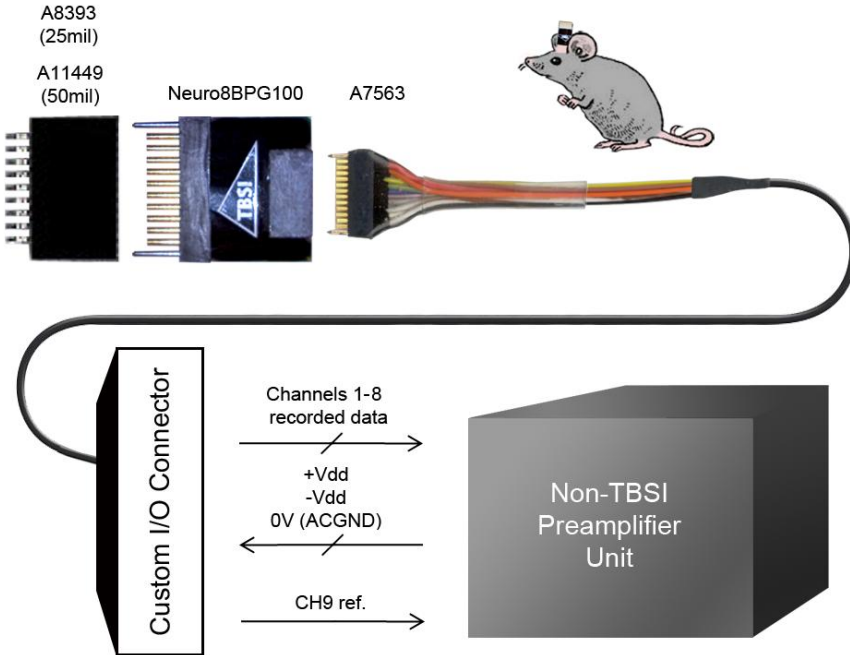

Available Grounding and Referencing Connections for T8G2 Headstage:

ACGND: Connect your animal ground to ACGND (see pinout diagram on pg2) of the headstage. This is typically connected to earth or system ground (which is 0V potential) of the recording system.

CH9: This is an extra recording channel that can be used as a common mode reference signal for external preamplifiers. This common mode reference channel is useful for removing animal movement artifacts or any other common mode noise found at the headstage input pins.

Front View

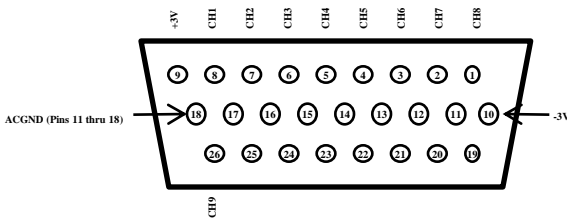

Rear View

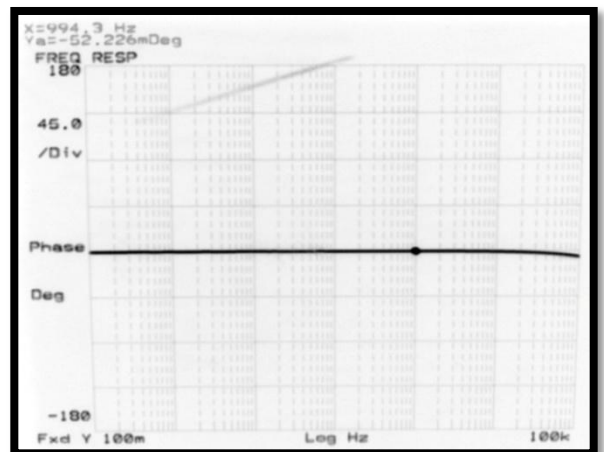
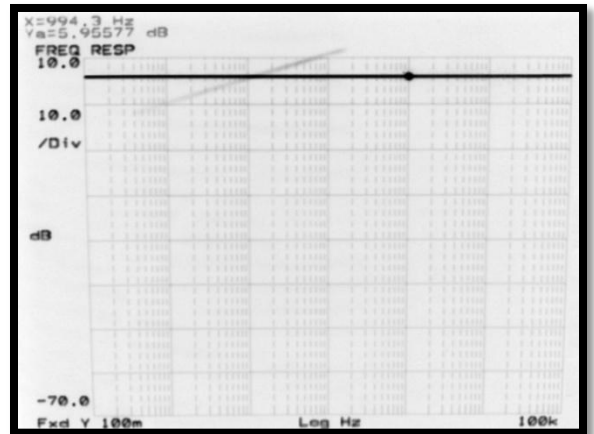

* 8ch T-series recording unit is exclusively powered via USB